



**EN** Operating instructions. . . . . pages 1 to 6  
Translation of the original operating instructions

**Content**

**1 About this document**

1.1 Function . . . . . 1

1.2 Target group: authorised qualified personnel. . . . . 1

1.3 Explanation of the symbols used . . . . . 1

1.4 Appropriate use . . . . . 1

1.5 General safety instructions . . . . . 1

1.6 Warning about misuse . . . . . 2

1.7 Exclusion of liability . . . . . 2

**2 Product description**

2.1 Ordering code . . . . . 2

2.2 Special versions. . . . . 2

2.3 Destination and use . . . . . 2

2.4 Technical data . . . . . 2

2.5 Safety classification . . . . . 3

**3 Mounting**

3.1 General mounting instructions . . . . . 3

3.2 Dimensions . . . . . 3

**4 Electrical connection**

4.1 General information for electrical connection. . . . . 3

**5 Operating principle and settings** . . . . . 3

**6 Set-up and maintenance**

6.1 Functional testing. . . . . 3

6.2 Maintenance . . . . . 3

**7 Disassembly and disposal**

7.1 Disassembly. . . . . 3

7.2 Disposal . . . . . 3

**8 Appendix**

8.1 Wiring examples . . . . . 4

8.2 Integral System Diagnostics (ISD). . . . . 5

**9 Declaration of conformity**

9.1 EC Declaration of conformity . . . . . 6

**1. About this document**

**1.1 Function**

This operating instructions manual provides all the information you need for the mounting, set-up and commissioning for the safe operation and disassembly of the safety-monitoring module. The operating instructions must be available in a legible condition and a complete version in the vicinity of the device.

**1.2 Target group: authorised qualified personnel**

All operations described in this operating instructions manual must be carried out by trained specialist personnel, authorised by the plant operator only.

Please make sure that you have read and understood these operating instructions and that you know all applicable legislations regarding occupational safety and accident prevention prior to installation and putting the component into operation.

The machine builder must carefully select the harmonised standards to be complied with as well as other technical specifications for the selection, mounting and integration of the components.

**1.3 Explanation of the symbols used**



**Information, hint, note:**

This symbol is used for identifying useful additional information.



**Caution:** Failure to comply with this warning notice could lead to failures or malfunctions.

**Warning:** Failure to comply with this warning notice could lead to physical injury and/or damage to the machine.

**1.4 Appropriate use**

The products described in these operating instructions are developed to execute safety-related functions as part of an entire plant or machine. It is the responsibility of the manufacturer of a machine or plant to ensure the correct functionality of the entire machinery or plant.

The safety-monitoring module must be exclusively used in accordance with the versions listed below or for the applications authorised by the manufacturer. Detailed information regarding the range of applications can be found in the chapter "Product description".

**1.5 General safety instructions**

The user must observe the safety instructions in this operating instructions manual, the country-specific installation standards as well as all prevailing safety regulations and accident prevention rules.



Further technical information can be found in the Schmersal catalogues or in the online catalogue on the Internet: [www.schmersal.net](http://www.schmersal.net).

The information contained in this operating instructions manual is provided without liability and is subject to technical modifications.

There are no residual risks, provided that the safety instructions as well as the instructions regarding mounting, commissioning, operation and maintenance are observed.

### 1.6 Warning about misuse



In case of inadequate or improper use or manipulations of the safety-monitoring module, personal hazards or damages to machinery or plant components cannot be excluded. The relevant requirements of the standard ISO 14119 must be observed.

### 1.7 Exclusion of liability

We shall accept no liability for damages and malfunctions resulting from defective mounting or failure to comply with this operating instructions manual. The manufacturer shall accept no liability for damages resulting from the use of unauthorised spare parts or accessories.

For safety reasons, invasive work on the device as well as arbitrary repairs, conversions and modifications to the device are strictly forbidden; the manufacturer shall accept no liability for damages resulting from such invasive work, arbitrary repairs, conversions and/or modifications to the device.

## 2. Product description

### 2.1 Ordering code

This operating instructions manual applies to the following types:

#### AES 1155<sup>①</sup>

No.	Option	Description
①	5	without start-up test
	6	with start-up test

#### AES 1165<sup>①</sup>

No.	Option	Description
①	5	without start-up test
	6	with start-up test



Only if the information described in this operating instructions manual are realised correctly, the safety function and therefore the compliance with the Machinery Directive is maintained.

### 2.2 Special versions

For special versions, which are not listed in the order code below 2.1, these specifications apply accordingly, provided that they correspond to the standard version.

### 2.3 Destination and use

The safety-monitoring modules for integration in safety circuits are designed for fitting in control cabinets. They are used for the safe evaluation of the signals of positive break position switches for safety functions or magnetic safety sensors on sliding, hinged and removable safety guards.

#### AES 1155/1156

Monitoring of two safety switches, which are simultaneously actuated by a safety guard (e.g. safety guard, diversitary actuation).

Monitoring of one or multiple safety guards in series-/parallel-wiring only possible with a AES 1155 and AES 1156 series safety-monitoring module. The number of connected safety switches is restricted by the contact transition resistance and the conduction resistance. This overall resistance must not exceed 300 Ω. For magnetic safety sensors with LED, the brightness of the LED's reduce as the amount of guard doors opened increases.

#### AES 1165/1166

Monitoring of two safety switches, which are actuated by different safety guards (e.g. two guard doors, which are opened independently from one another).

#### Design

The safety-monitoring modules have a dual-channel structure. They contain two safety relays with monitored positively driven contacts. The NO contacts of the relays, which are wired in series, build the enabling contacts.



The entire concept of the control system, in which the safety component is integrated, must be validated to the relevant standards.

### 2.4 Technical data

Standards:	IEC 60204-1, IEC 60947-5-3, ISO 13849-1, IEC 61508, BG-GS-ET-14, BG-GS-ET-20
Start conditions:	Automatic
Feedback circuit available:	no
Start-up test:	AES ...5: no; AES ...6: yes
Pull-in delay for automatic start:	adjustable 0.1 / 1.0 second
Drop-out delay in case of "emergency stop":	< 50 ms
Rated operating voltage $U_e$ :	24 VDC $\pm$ 15%
Rated operating current $I_e$ :	0.2 A
Rated insulation voltage $U_i$ :	250 V
Rated impulse withstand voltage $U_{imp}$ :	4.8 kV
Thermal test current $I_{the}$ :	6 A
Internal electronic fuse:	no
Power consumption:	< 5 W
Monitored inputs:	
Cross-wire short detection:	no
Wire breakage detection:	yes
Earth connection detection:	yes
Number of NC contacts:	2
Number of NO contacts:	2
Outputs:	
Stop category 0:	1
Stop category 1:	0
Number of safety contacts:	1
Number of auxiliary contacts:	0
Switching capacity of the safety contacts:	min. 10 mA max. 6 A
Utilisation category to EN 60947-5-1:	AC-15: 230 V / 3 A DC-13: 24 V / 2 A
Max. fuse rating:	6 A gG D-fuse
Mechanical life:	20 million operations
LED display:	ISD
Ambient conditions:	
Operating temperature:	0 °C ... +55 °C
Storage and transport temperature:	-25 °C ... +70 °C
Protection class:	Enclosure: IP40 Terminals: IP20 Clearance: IP54
Degree of pollution:	2
Mounting:	snaps onto standard DIN rail to EN 60715
Connection type:	Screw connection
Min. cable section:	0.25 mm <sup>2</sup>
Max. cable section:	2.5 mm <sup>2</sup> , solid strand or multi-strand lead (including conductor ferrules)
Tightening torque:	0.6 Nm
Max. cable length:	1000 m of 0.75 mm <sup>2</sup> conductor
Weight:	190 g
Dimensions (H x W x D):	100 x 22.5 x 121 mm

## 2.5 Safety classification

Standards:	ISO 13849-1, IEC 61508
PL:	up to d
Control category:	up to 3
PFH-value:	1,0 x 10 <sup>-7</sup> / h; Applicable for applications with up to max. 50,000 switching cycles / year and max. 80 % contact load. Diverging applications upon request.
SIL:	up to 2
Service life:	20 years

## 3. Mounting

### 3.1 General mounting instructions

Mounting: snaps onto standard DIN rails to EN 60715.

### 3.2 Dimensions

Device dimensions (H/W/D): 100 x 22.5 x 121 mm

## 4. Electrical connection

### 4.1 General information for electrical connection



The electrical connection may only be carried out by authorised personnel in a de-energised condition.

Wiring examples: see appendix

## 5. Operating principle and settings

### Operating principle after the operating voltage is switched on

Without start-up test AES 1155 / 1165

1. The functionality of the safety-monitoring module is tested.
2. If the safety guard is closed or the emergency stop button released, the enabling paths of the safety-monitoring module will close. The LED is green.
3. The cable and the connected safety switch are only tested when the safety guard is opened or the emergency stop button when actuated

### With start-up test AES 1156 / 1166

1. The functionality of the safety-monitoring module is tested.
2. The safety guard or the emergency stop button must be actuated, in order to check the cables and the connected safety switch (start-up test).
3. If the safety guard is closed or the emergency stop button released, the enabling paths of the safety-monitoring module will close. The LED is green.

If the safety guard is opened or the emergency-stop button is actuated, the enabling paths of the safety-monitoring module will open. The machine is stopped and the LED flashes yellow.

### Inputs S1-S14/S22; S2-S14/S22

Connect a safety switch with one NC and one NO contact or two safety switches with one contact each or an emergency-stop button at input S14/S22.

### Outputs

Enabling paths 13-14: NO contacts for safety functions

### Enable delay time

The enable delay time can be increased from 0.1 s to 1 s by changing the position of a jumper link connection. Remove the enclosure cover carefully by means of a screwdriver. Change the position of the jumper link connection B1.

Jumper link connection closed = 1 s

## 6. Set-up and maintenance

### 6.1 Functional testing

The safety function of the safety-monitoring module must be tested.

The following conditions must be previously checked and met:

1. Correct fitting of the safety-monitoring module
2. Fitting and integrity of the power cable

### 6.2 Maintenance

In the case of correct installation and adequate use, the safety-monitoring module features maintenance-free functionality.

A regular visual inspection and functional test, including the following steps, is recommended:

- Check the correct fixing of the safety monitoring module
- Check the cable for damage.

**Damaged or defective components must be replaced.**

## 7. Disassembly and disposal

### 7.1 Disassembly

The safety monitoring module must be disassembled in the de-energised condition only.

### 7.2 Disposal

The safety monitoring module must be disposed of in an appropriate manner in accordance with the national prescriptions and legislations.

8. Appendix

8.1 Wiring examples

The application examples shown are suggestions. They however do not release the user from carefully checking whether the switchgear and its set-up are suitable for the individual application.

The wiring diagram is shown with guard doors closed and in a de-energised condition. Inductive loads (e.g. contactors, relays, etc.) are to be provided with suitable interference suppression circuitry. Do not connect additional loads to terminal S..

AES 1155 / 1156

Monitoring of four safety guards (cascading) by means of a magnetic safety sensor

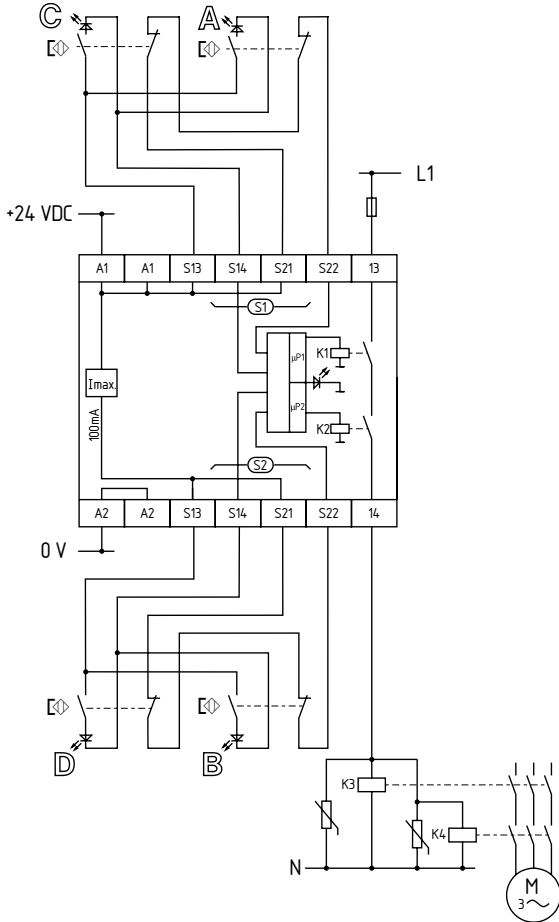

AES 1165 / 1166

Monitoring of two safety guards with two position switches with safety function

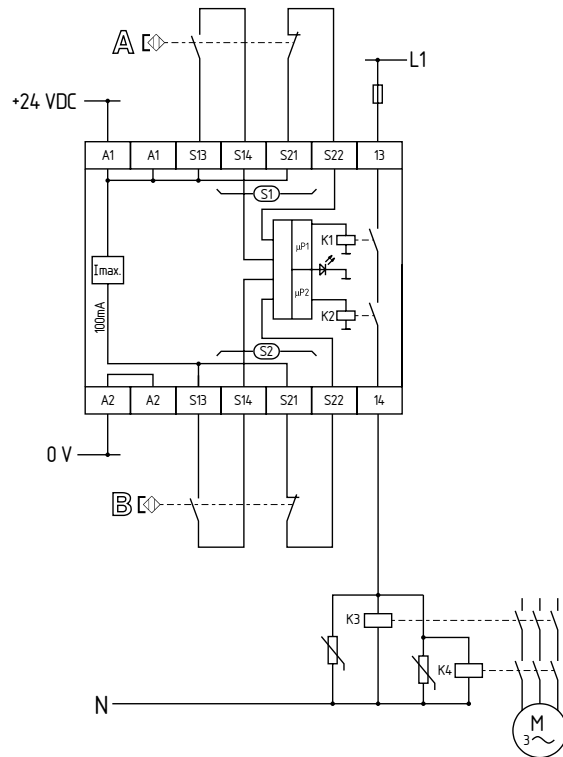

Key

A - D Non-contact safety sensor



**8.2 Integral System Diagnostics (ISD)**

The safety monitoring modules LED display to show the different switching conditions and faults. The following tables show the different switching conditions.







**Tables switching condition indication**

Indication LED	System condition
The LED is green.	Enabling paths closed
LED flashes yellow (0.5 Hz)	Enabling paths open
LED flashes yellow (2 Hz)	Safety guard closed, however no authorised operation; possible cause: incorrect operation (only one contact was actuated when the safety guard was opened) or voltage drop or feedback loop not closed → perform start-up test

**AES 1165 / 1166 with two additional LED indications.**

Indication LED (yellow)	System condition
1 impulse 	Safety guard 1 open
2 impulses 	Safety guard 2 open

**Table error indications**

Indication LED (orange)	Error	Cause
1 impulse 	Inputs S1	Defective supply voltage lead, defective switch, erroneous fitting of the switch; switch only partially actuated* for at least 5 s
2 impulses 	Inputs S2	Refer to errors inputs S1
3 impulses 	Inputs S1 and S2	Refer to errors inputs S1
4 impulses 	Interference signals at the inputs (no safe evaluation assured)	Too high capacitive or inductive interference at the switch's cables or the supply voltage lead
5 impulses 	One or both relays did not close within the monitoring time	Too low operating voltage U <sub>e</sub> ; defective relay
6 impulses 	Relay not disabled upon the actuation of the switch	May be due to contact welding
7 impulses 	Dynamic monitoring of both channels (cross-monitoring) failure	Fault in one channel; internal data transmission interrupted

\* Partial actuation: position of the switch, in which only one contact was actuated.

**Deleting the error message**

The error message is deleted once the fault has been rectified and after the connected switch has been actuated to check the various functions (open and then close the safety guard).

9. Declaration of conformity

9.1 EC Declaration of conformity

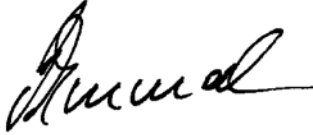
	
<b>EC Declaration of conformity</b>	
Translation of the original Declaration of Conformity	K.A. Schmersal GmbH & Co. KG Möddinghofe 30 42279 Wuppertal Germany Internet: www.schmersal.com
We hereby certify that the hereafter described safety components both in its basic design and construction conform to the applicable European Directives.	
<b>Name of the safety component:</b>	AES 1155 / AES 1156 / AES 1165 / AES 1166
<b>Description of the safety component:</b>	Safety-monitoring module for non-contact safety switches and safety relay combination in connection with the BNS series magnetic safety switches
<b>Relevant EC-Directives:</b>	2006/42/EC EC-Machinery Directive 2004/108/EC EMC-Directive
<b>Person authorised for the compilation of the technical documentation:</b>	Oliver Wacker Möddinghofe 30 42279 Wuppertal
<b>Notified body, which approved the full quality assurance system, referred to in Appendix X, 2006/42/EC:</b>	TÜV Rheinland Industrie Service GmbH Alboinstrasse 56 12103 Berlin ID n°: 0035
<b>Place and date of issue:</b>	Wuppertal, August 18, 2015
AES1155-C-EN	
	Authorised signature <b>Philip Schmersal</b> Managing Director



The currently valid declaration of conformity can be downloaded from the internet at [www.schmersal.net](http://www.schmersal.net).



**K.A. Schmersal GmbH & Co. KG**  
Möddinghofe 30, D - 42279 Wuppertal  
Postfach 24 02 63, D - 42232 Wuppertal

Phone: +49 - (0)2 02 - 64 74 - 0  
Telefax: +49 - (0)2 02 - 64 74 - 1 00  
E-Mail: [info@schmersal.com](mailto:info@schmersal.com)  
Internet: <http://www.schmersal.com>